

BAY/BOW

SIZE TABLES - CASEMENT BAY / ANGLE JAMB

Aluminum-Clad Wood

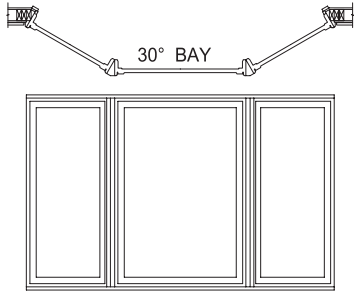

30 DEGREE BAY - 41" CENTER UNIT

Flanker Frame Width Inches (mm)	A R.O. Width Inches (mm)	B M.O. Width Inches (mm)	C Overall Projection Inches (mm)	D Overall Unit Width Inches (mm)
17" (432)	6' 3-3/16" (1 909)	6' 7-7/16" (2 018)	10-9/16" (268)	6' 3-7/16" (1 916)
21" (533)	6' 10-1/8" (2 085)	7' 2-3/8" (2 194)	12-9/16" (319)	6' 10-3/8" (2 092)
23" (584)	7' 1-9/16" (2 173)	7' 5-13/16" (2 282)	1' 1-9/16" (345)	7' 1-13/16" (2 180)
25" (635)	7' 5" (2 261)	7' 9-5/16" (2 370)	1' 2-9/16" (370)	7' 5-5/16" (2 268)
29" (737)	7' 11-15/16" (2 437)	8' 4-1/4" (2 546)	1' 4-9/16" (421)	8' 0-1/4" (2 444)
35" (889)	8' 10-3/8" (2 701)	9' 2-5/8" (2 810)	1' 7-9/16" (497)	8' 10-5/8" (2 708)

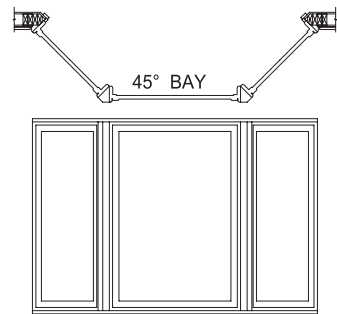

45 DEGREE BAY - 41" CENTER UNIT

Flanker Frame Width Inches (mm)	A R.O. Width Inches (mm)	B M.O. Width Inches (mm)	C Overall Projection Inches (mm)	D Overall Unit Width Inches (mm)
17" (432)	5' 11-7/16" (1 814)	6' 4-1/8" (1 933)	1' 2-15/16" (379)	6' 0-1/8" (1 832)
21" (533)	6' 5-1/16" (1 958)	6' 9-3/4" (2 077)	1' 5-3/4" (451)	6' 5-3/4" (1 975)
23" (584)	6' 7-15/16" (2 030)	7' 0-5/8" (2 149)	1' 7-3/16" (487)	6' 8-5/8" (2 047)
25" (635)	6' 10-3/4" (2 102)	7' 3-7/16" (2 221)	1' 8-5/8" (524)	6' 11-7/16" (2 119)
29" (737)	7' 4-3/8" (2 245)	7' 9-1/16" (2 364)	1' 11-7/16" (595)	7' 5-1/16" (2 263)
35" (889)	8' 0-7/8" (2 461)	8' 5-9/16" (2 580)	2' 3-11/16" (703)	8' 1-9/16" (2 478)

- Bay window combinations are not AAMA/WDMA performance rated.

- For center unit frame width other than those shown:

Greater than 41" - add difference between 41" and greater frame width to dimensions A, B and D.

Less than 41" - subtract difference between 41" and smaller frame width from dimensions A, B and D.

- Dimensioning points are shown in details.

- Overall projection (C dimension) is sheathing to face of bay. For sheathing to sheathing (walk-in bay) subtract 1-1/4".

- Specify height of window units to be used in bay.

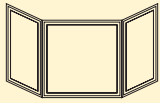

BAY/BOW

SIZE TABLES - DOUBLE-HUNG BAY / ANGLE JAMB

Aluminum-Clad Wood

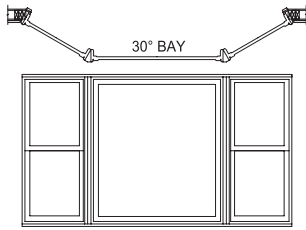

30 DEGREE BAY - 53" CENTER UNIT

Flanker Frame Width Inches (mm)	A R.O. Width Inches (mm)	B M.O. Width Inches (mm)	C Overall Projection Inches (mm)	D Overall Unit Width Inches (mm)
FACTORY ASSEMBLED				
21" (533)	7' 10-1/8" (2 391)	8' 2-3/8" (2 499)	12-9/16" (319)	7' 10-3/8" (2 397)
25" (635)	8' 5" (2 565)	8' 9-5/16" (2 675)	1' 2-9/16" (370)	8' 5-5/16" (2 573)
29" (737)	9' 0" (2 743)	9' 4-1/4" (2 851)	1' 4-9/16" (421)	9' 0-1/4" (2 750)
NON-FACTORY ASSEMBLED				
33" (838)	9' 6-7/8" (2 918)	9' 11-3/16" (3 027)	1' 6-9/16" (472)	9' 7-3/16" (2 926)
37" (940)	10' 1-7/8" (3 096)	10' 6-1/16" (3 202)	1' 8-9/16" (522)	10' 2-1/16" (3 100)
41" (1 041)	10' 8-3/4" (3 270)	11' 1" (3 378)	1' 10-9/16" (573)	10' 9" (3 277)
45" (1 143) ₁	11' 3-5/8" (3 445)	11' 7-15/16" (3 554)	2' 0-9/16" (624)	11' 3-15/16" (3 453)

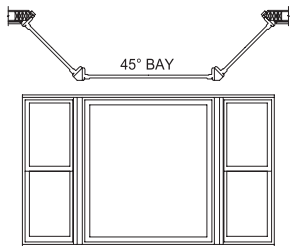

45 DEGREE BAY - 53" CENTER UNIT

Flanker Frame Width Inches (mm)	A R.O. Width Inches (mm)	B M.O. Width Inches (mm)	C Overall Projection Inches (mm)	D Overall Unit Width Inches (mm)
FACTORY ASSEMBLED				
21" (533)	7' 5-1/8" (2 264)	7' 9-3/4" (2 381)	1' 5-3/4" (451)	7' 5-3/4" (2 280)
25" (635)	7' 10-3/4" (2 407)	8' 3-7/16" (2 526)	1' 8-5/8" (524)	7' 11-7/16" (2 424)
29" (737)	8' 4-3/8" (2 550)	8' 9-1/16" (2 669)	1' 11-7/16" (595)	8' 5-1/16" (2 567)
NON-FACTORY ASSEMBLED				
33" (838)	8' 10" (2 692)	9' 2-3/4" (2 813)	2' 2-1/4" (667)	8' 10-3/4" (2 711)
37" (940)	9' 3-3/4" (2 838)	9' 8-3/8" (2 956)	2' 5-1/16" (738)	9' 4-3/8" (2 854)
41" (1 041)	9' 9-3/8" (2 981)	10' 2-1/16" (3 100)	2' 7-15/16" (811)	9' 10-1/16" (2 999)

(1) Available in Architect Series and Designer Series Only.

- Bay window combinations are not AAMA/WDMA performance rated.
- For center unit frame width other than those shown:

Greater than 53" - add difference between 53" and greater frame width to dimensions A, B and D.

Less than 53" - Fixed Unit—subtract difference between 53" and smaller frame width from dimensions A, B and D.

- Dimensioning points are shown in details.
- Overall projection (C dimension) is sheathing to face of bay. For sheathing to sheathing (walk-in bay) subtract 1-1/4".
- Specify height of window units to be used in bay.

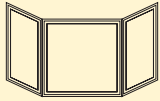

BAY/BOW

SIZE TABLES - CASEMENT BOW / ANGLE JAMB

Aluminum-Clad Wood

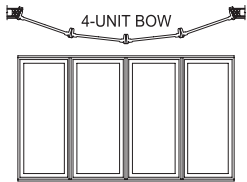

4-UNIT

Flanker Frame Width Inches (mm)	Radius	A	B	C	D
		R.O. Width Inches (mm)	M.O. Width Inches (mm)	Overall Projection Inches (mm)	Overall Unit Width Inches (mm)
17" (432)	6' 4-1/16" (1 932)	5' 9-1/8" (1 755)	6' 1-3/16" (1 859)	1-1/16" (230)	5' 9-3/16" (1 757)
21" (533)	7' 10" (2 387)	7' 0-5/8" (2 149)	7' 4-11/16" (2 253)	10-13/16" (275)	7' 0-11/16" (2 151)
23" (584)	8' 6-15/16" (2 614)	7' 8-3/8" (2 346)	8' 0-7/16" (2 450)	11-11/16" (297)	7' 8-7/16" (2 348)
25" (635)	9' 3-7/8" (2 842)	8' 4-1/8" (2 543)	8' 8-3/16" (2 647)	12-9/16" (319)	8' 4-3/16" (2 545)
29" (737)	10' 9-3/4" (3 296)	9' 7-5/8" (2 937)	9' 11-11/16" (3 041)	1' 2-5/16" (364)	9' 7-11/16" (2 939)
35" (889)	13' 0-5/8" (3 978)	11' 6-7/8" (3 528)	11' 11" (3 632)	1' 4-15/16" (430)	11' 7" (3 530)

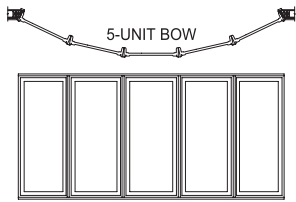

5-UNIT

Flanker Frame Width Inches (mm)	Radius	A	B	C	D
		R.O. Width Inches (mm)	M.O. Width Inches (mm)	Overall Projection Inches (mm)	Overall Unit Width Inches (mm)
17" (432)	6' 4-1/16" (1 932)	7' 1" (2 156)	7' 5-1/8" (2 265)	12-15/16" (329)	7' 1-1/8" (2 163)
21" (533)	7' 10" (2 387)	8' 8" (2 642)	9' 0-3/16" (2 748)	1' 3-1/2" (394)	8' 8-3/16" (2 646)
23" (584)	8' 6-15/16" (2 614)	9' 5-1/4" (2 883)	9' 9-11/16" (2 989)	1' 4-3/16" (427)	9' 5-11/16" (2 888)
25" (635)	9' 3-7/8" (2 842)	10' 3" (3 125)	10' 7-3/16" (3 231)	1' 6-1/8" (460)	10' 3-3/16" (3 129)
29" (737)	10' 9-13/16" (3 296)	11' 10-1/16" (3 608)	12' 2-1/4" (3 714)	1' 8-3/4" (527)	11' 10-1/4" (3 613)
35" (889)*	13' 0-5/8" (3 978)	14' 2-9/16" (4 333)	14' 6-3/4" (4 439)	2' 0-5/8" (626)	14' 2-3/4" (4 337)

* Not Factory Assembled

- Bow window combinations are not AAMA/WDMA performance rated.
- Dimensioning points are shown in details.
- Overall projection (C dimension) is sheathing to face of bow. For sheathing to sheathing (walk-in bow) subtract 1-1/4".
- Specify height of window units to be used in bow.